

Service

MANUAL

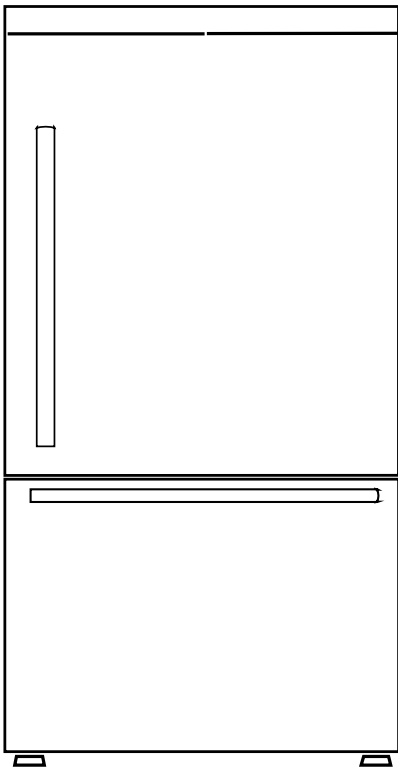

REFRIGERATOR

– Notice –

This Manual is prepared for the use of trained Service Technicians and should not be used by those not properly qualified. This Manual is not intended to be all-encompassing. You should read, in its entirety, the repair procedure you wish to perform to determine if you have the necessary tools, instruments, and skills required to perform the procedure. Procedures for which you do not have the necessary tools, instruments, and skills should be performed by a trained Service Technician.

Serial Number	3
Safety Information	4
Installation, Electrical & Plumbing Requirements	6
Theory of Operation	7
Refrigerator Components	8
Freezer Components	9
Rear & Compressor Area Components	10
Gas Flow Diagram & Parts	11
Electrical Components & Specifications	12
Display & User Option Settings	13
Error Codes & Control Board Connections	15
F1 & F2	16
F3 & F4	17
F5 & F6	18
CE & 1E	19
2E & 3E	20
DR	21
Maintenance guide for refrigeration failure	21
Guide to maintenance of ice making faults	22
High Temp Error & Temperature to Resistance Chart	23
Wiring Diagram	24
Control Board Test Points	25
Main control board led flashing fault	26
Component Access & Removal	27
Control Board	27
Display	28
Sensor	29
Light Switch	30
LED Light	31
Refrigerator rail removal	33
Vegetable box & Freezing drawer	34
Freezer rails	35
Freezer top drawer & Handles	36
Ice Maker & Freezer the Rear Wall	37
Removing the Rear Wall & water valve	38
Water Dispenser & Microswitch & valve	39
Defrost Element & Thermal Fuse & Condenser Fan	40
Troubleshooting	41
Warranty	43

Serial Number

The serial tag is located on either the upper left-hand wall of the refrigerator section, or bottom of the compartment, beneath the large crisper drawer.



SAVE THESE INSTRUCTIONS

REVIEW ALL SERVICE INFORMATION IN THIS SERVICE MANUAL BEFORE BEGINNING REPAIRS.

This product should only be serviced by a qualified service technician, who is familiar with the standard safety procedures required for servicing this product. The technician should be equipped with the proper tools, parts, and test equipment before beginning.

Safety Information

We have provided many important safety messages in this manual and on the appliance. ALWAYS READ AND OBEY ALL SAFETY MESSAGES.

This is the safety alert symbol



This symbol alerts you to hazards that could cause death or injury to you or others, or cause damage to product or property. Each occurrence will identify the hazard, describe how to reduce the chance of injury, and describe what can happen if the instructions are not followed. The symbol will be surrounded by a color which corresponds to a particular type of hazard. Red for DANGER, Orange for WARNING, and Yellow for CAUTION.

These categories are defined in the boxes to the right

	<p>DANGER</p> <p>INDICATES A HAZARDOUS SITUATION WHICH, IF NOT AVOIDED, WILL RESULT IN DEATH OR SERIOUS INJURY.</p>
-------------------------------------------------------------------------------------	----------------------------------------------------------------------------------------------------------------------------

	<p>WARNING</p> <p>Indicates a hazardous situation which, if not avoided, could result in death or serious injury. Repairs should not be attempted by unauthorized personnel.</p>
--------------------------------------------------------------------------------------	-----------------------------------------------------------------------------------------------------------------------------------------------------------------------------------------

	<p>CAUTION</p> <p>Indicates a hazardous situation which, if not avoided, could result in minor personal injury or product or property damage.</p>
--------------------------------------------------------------------------------------	----------------------------------------------------------------------------------------------------------------------------------------------------------

Safety Instructions

The manufacturer reserves the right to make changes in the technical specifications in order to improve the appliance quality without any prior notice. Figures included in this manual are for schematic purposes only and may not match the appliance exactly. Values stated on the markings of the appliance, or in other printed documents supplied with the appliance, are obtained under laboratory conditions as per relevant standards. These values may vary according to the usage of the appliance and ambient conditions.

Proper Installation - Be sure your appliance is properly installed and grounded by a qualified technician.

If the supplied electrical cord is damaged, it must be replaced by a power cord or assembly from the manufacturer. It must also be installed by a qualified service technician.



Service repairs must always be performed by an Authorized Servicer. Installations must be performed by a Certified Installer (This can include certified and licensed electrician or plumbers. The Manufacturer cannot be held responsible for damages caused by operations performed by unauthorized, un-certified or unlicensed persons.

- If the refrigerator is malfunctioning, it must not be operated until it is repaired by an Authorized Servicer. There is a risk of electrical shock!
- The unit should be plugged into a three-prong, grounded and polarized 15A, 120V, 60Hz dedicated wall outlet. Our company will not be responsible for damages incurred while using the product in a way that does not comply with the electrical code of the location where the product is installed.
- If the unit is not going to be used for an extended period of time, turn off the power to it via the circuit breaker, shut off the water supply, and leave the doors open.
- Never wash the refrigerator by spraying or pouring water on it. There is a risk of electric shock!
- Caution should be used when unplugging the unit for service. Make sure your hands are not wet, and always hold the plug when disconnecting from the outlet, not the cord. If the outlet is loose, have a licensed electrician repair or replace the outlet.
- This unit was designed to operate on a normal 60Hz, 120VAC electrical grid system. If it is connected to any energy saving system, alternative power, or solar power system, etc. and is experiencing any operational issues, please contact your local electrical provided for further information.
- Shut off power to the refrigerator at the circuit breaker during installation, cleaning near exposed electrical components, or service repairs.

Installation, Electrical & Plumbing Requirements

- The refrigerator must not be located too close to a heat source. Be sure it is installed at least 12" (30cm) from cooktops, ovens, radiators or stoves, and at least 2" (5cm) from electric ovens. Also, be sure the unit is not subject to direct sunlight or excessively humid locations.
- Do not install the refrigerator in place where the temperature falls below 50°F/10°C.
- Do not block the ventilation grill in the bottom to ensure proper ventilation (cooling air intake).



1 3/4" (4cm) between them.

- This product requires a 120VAC, 60Hz service.
- The electrical connection must comply with national regulations.
- Be sure power cable is accessible after installation.
- Do not make connections via extension cords or multi-plugs.
- Rated total current draw is 2.7A. A circuit breaker above this amount must be used, in compliance with local regulations.
- GFCI outlets will provide added protection, but any failure of the GFCI could cause food spoilage, which is not covered by the manufacturer's warranty.



WARNING: A damaged power cord must be replaced by an Authorized Service Technician.

- The refrigerator should only be connected to the cold water line.
- Operating pressure should be between 25psi (1.7 bars) and 125 psi. (8.6 bars)
- If water pressure exceeds 80psi (5.5 bars), a pressure limiting device should be used.
- Reverse Osmosis systems are not recommended due to decreased water pressure and excessive air in the line.

Theory of Operation

Compressor & Evaporators

The refrigerator has two evaporators, but only one compressor, charged with R600a refrigerant. The Fresh Food and Freezer compartments are sealed off from each other. As there is no transfer of air between the two compartments, the temperature management for each compartment is accomplished by the individual evaporators and sensors. A refrigerant valve is used to regulate the flow of gas between the two evaporators.

Display

The Display is the operational interface for the customer. For information about each key and option, see the description below

Temperature Sensors

There are six thermistors on this product - One for the Outside top of refrigerator (Ambient), One for the Special fridge (Air), Two for the Fresh Food (Air & Evaporator), Two for the Freezer (Air & Evaporator). All of these sensors are NTC thermistors. Temperature information is transmitted to the main board via changes in their resistance. These thermistors ensure that the product operates according to the parameters set by the system software.

Heating Elements

There are six heating elements on this refrigerator - a Fresh Food Heater (evaporator), a Freezer Heater (evaporator), a Fresh Food Drain Heater (not accessible), Two Fill Tube Heaters, an Ice Maker Heater (The Flapper, Fill Tube Heaters and Ice Maker Heater are in a parallel circuit), The Defrost and Drain Heaters are in a parallel circuit. The refrigeration and freezing defrosting are synchronized, and the maximum defrosting time is limited to less than 50 minutes. When the sensor detects the temperature $\geq 46^{\circ}\text{F}/8^{\circ}\text{C}$ during defrosting, the defrosting will be stopped. After defrosting, delay 5 minutes for the compressor to start, and 3 minutes for the fan to run after the compressor starts.

Fans

There are three fans on this product - a Fresh Food Fan, a Freezer Fan, a Condenser Fan, All fans are 12VDC, and directly powered by the Main Control Board. The Fresh Food and Freezer Fans ensure proper air movement in their respective compartments. The condenser assembly in the compressor area is used to expel the heat pulled from all compartments. The Condenser Fan accelerates this heat transfer.

Ice Makers & Water Valves

There are a 115VAC motor twist the ice trays to eject the ice cubes.

A water valve is used to send water to the ice trays after each ice harvest. No flow meter is used to measure the water amount. A solenoid on the main water valve assembly is energized for the time set by the system software. A secondary water valve, located inside the partition between the crisper drawers, is energized when the microswitch at the dispenser is depressed.

Lights

12VDC LED light boards are used to illuminate Freezer and Fresh Food Compartments. Reed switches at the top of the doors activate the lights when a door is opened.

Controller

All the components listed above are operated by the Main Control Board located at the top of the product. Access to this, and all other components, is explained in the disassembly section of this manual.

Refrigerator Components

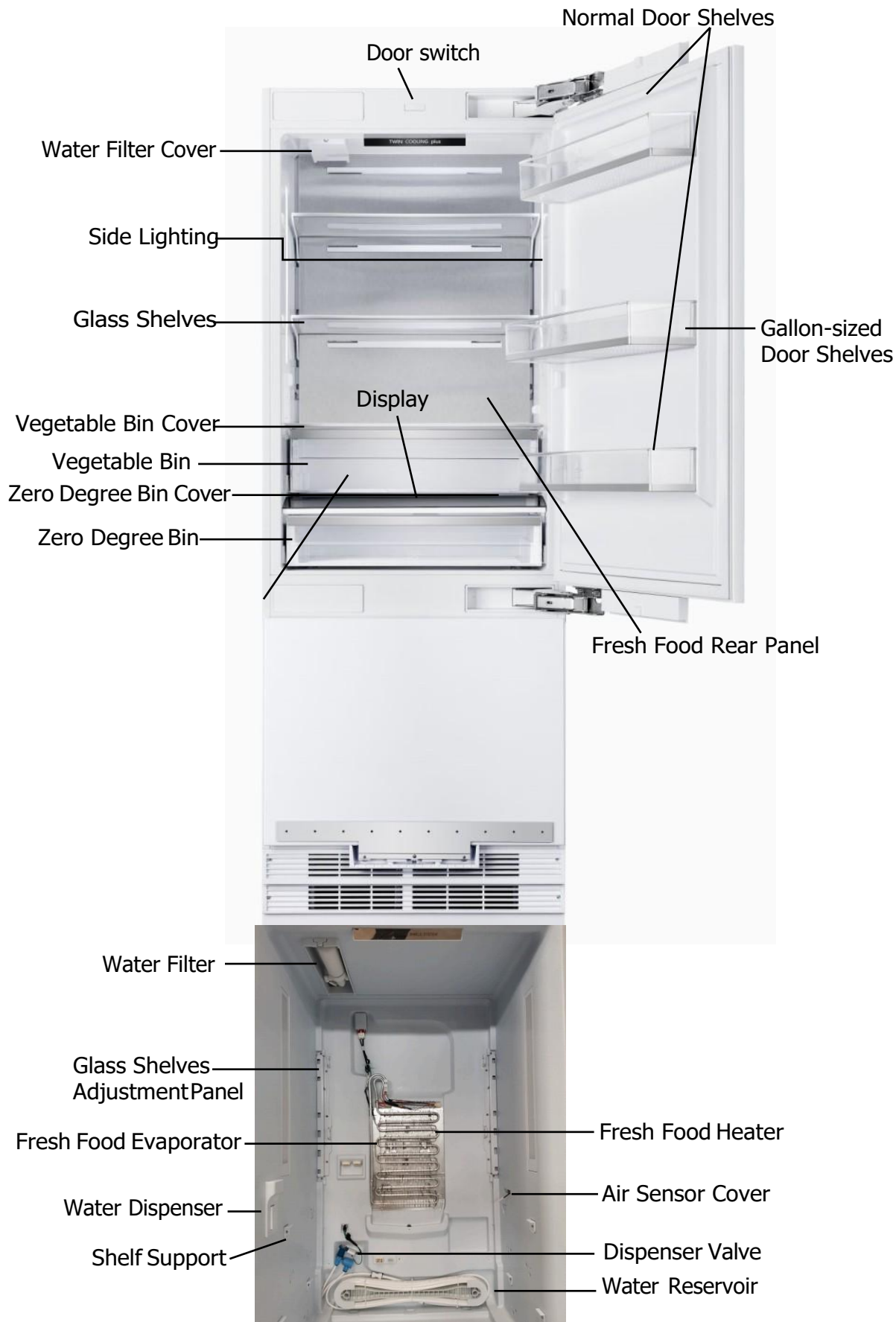

Freezer Components

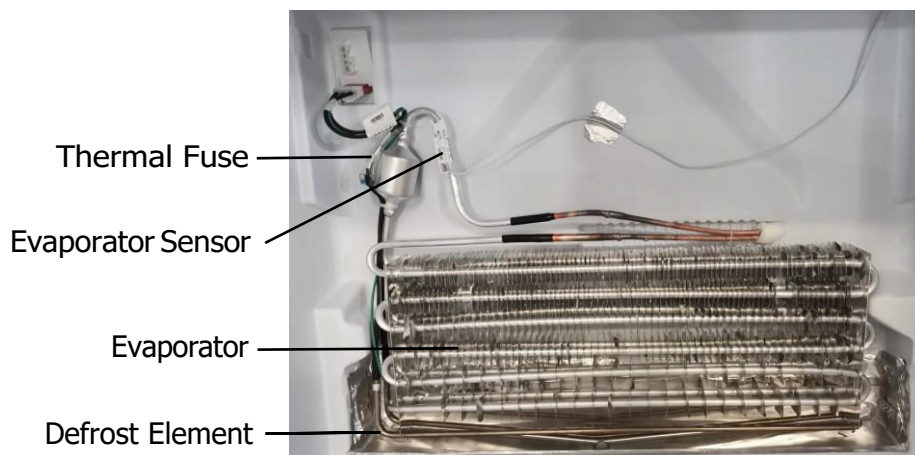

Rear & Compressor Area Components



Rear Access Panel



Fill Tube Heaters & Water Lines



Control board repair from the lower right of the front



Condenser Fan

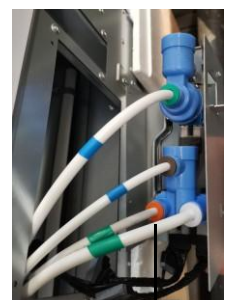

Water Valve

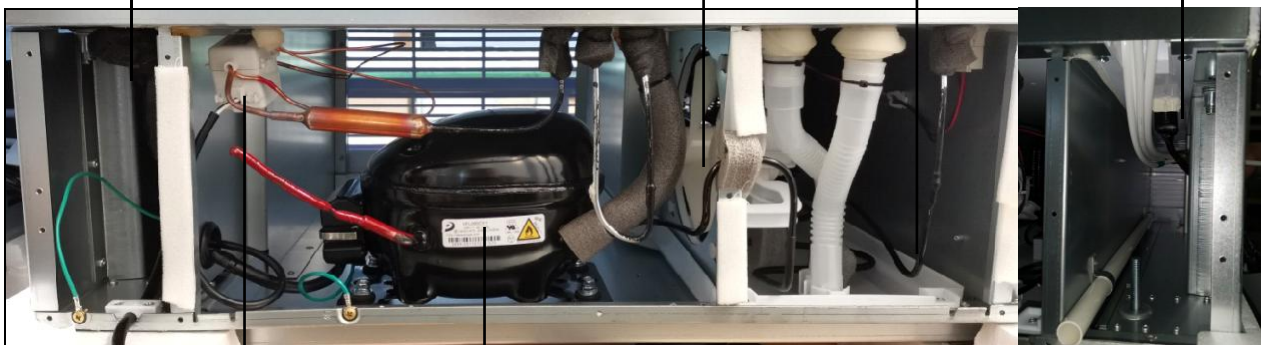

Solenoid valve

Compressor

Gas Flow Diagram & Parts



This refrigerator utilizes a cooling system using R600a refrigerant. Take care to avoid damaging the cooling system and its pipes while using and moving the unit. This gas is flammable. If the cooling system is damaged, keep the unit away from potential sources of fire and ventilate the room immediately.

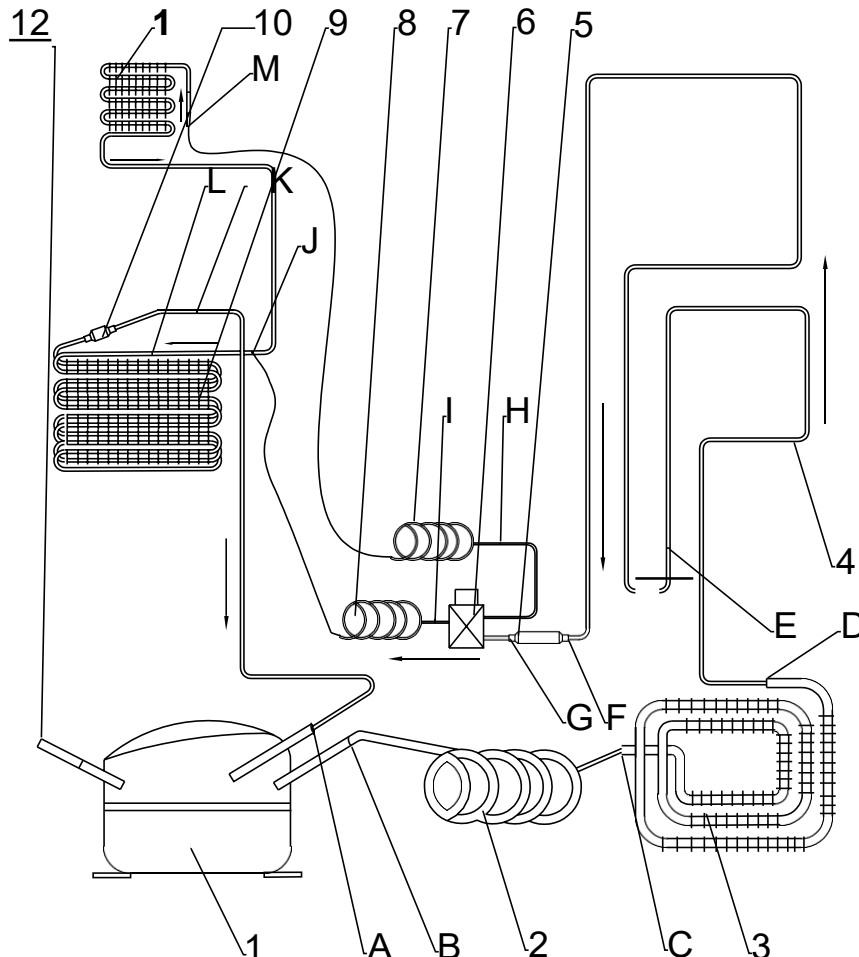

Cooling System Components

- 1- Compressor
- 2- Exhaust evaporation tube
- 3- Condenser
- 4- Freezer and Fridge Heater pipe
- 5- Drier
- 6- Solenoid valve
- 7- Fridge Capillary
- 8- Freezer Capillary
- 9- Frz Evaporator
- 10- Reservoir
- 11- FF Evaporator
- 12- Service pipe

Welding Point

- A-Connector pipe / Compressor
- B-Compressor / Exhaust evaporation tube
- C- Exhaust evaporation tube / Condenser
- D- Condenser / Freezer Heater Pipe
- E- Freezer Heater Pipe / Fridge Heater Pipe
- F- Fridge Heater Pipe / Drier
- G-Drier / Solenoid valve
- H-Solenoid valve / Fridge Capillary Tube
- I - Solenoid valve / Freezer Capillary Tube
- J -Freezer Capillary Tube / Frz Evaporator
- K-Frz Evaporator / Suction Pipe
- L-Frz Evaporator / FF Evaporator
- M- FF Evaporator / Fridge Capillary Tube

Electrical Components & Specifications

Quantity	Component	Stock Number	Specifications
1	Compressor	1.10.12090E-4XX	110VDC, 60Hz R600a
2	Solenoid valve	1.27.06A0XX-000	110VDC,15W
3	Freezer Fan Motor	1.33.DTQ431-041	12VDC,2W± 20%,CCW-1600RPM±200
4	Fresh Food Fan Motor	1.33.DTQ433-386	12VDC,2W± 20%,CCW-1600RPM±200
5	Condenser Fan Motor	1.33.ATQ130-368	12Vφ150
6	LED Board (TOP)	1.06.TQ4772-368	12VDC10*180
7	LED Board (SIDE)	1.06.TQ4771-368	12VDC
8	LEDBoard(VARIABLE)	1.30.3D3604-368	12VDC
9	LED Board (FREEZER)	1.06.TQ4772-368	12VDC10*180
10	Fridge Defrost Heater	1.08.140000-368	115VA , 20W
11	Freezer Defrost Heater	1.08.140100-368	115VA , 200W
12	Ice Maker Water Valve	1.31.A7241X-368	110-127 VAC, 60Hz
13	Valvefor drink	1.31.A7242X-368	110-127 VAC, 60Hz
14	Ice Maker	1.27.18A0XX-368	115VAC,165W+/-5%
15	Display Board	1.27.03A1XX-368	5VDC
16	Thermal Fuse	1.36.ATQ105-368	250V/1.25A
17	Control Board	1.27.01A202-368	Input voltage:120VACOutput: 5V-12VDC
18	Freezer Door switch	1.29.11X101-000	6A,125V
19	Fresh Food Reed Switches	1.11.02341TQ-01	5VDC

*Note: For the exact stock number information, look at the BOM List .

Display Panel SetUp Instructions

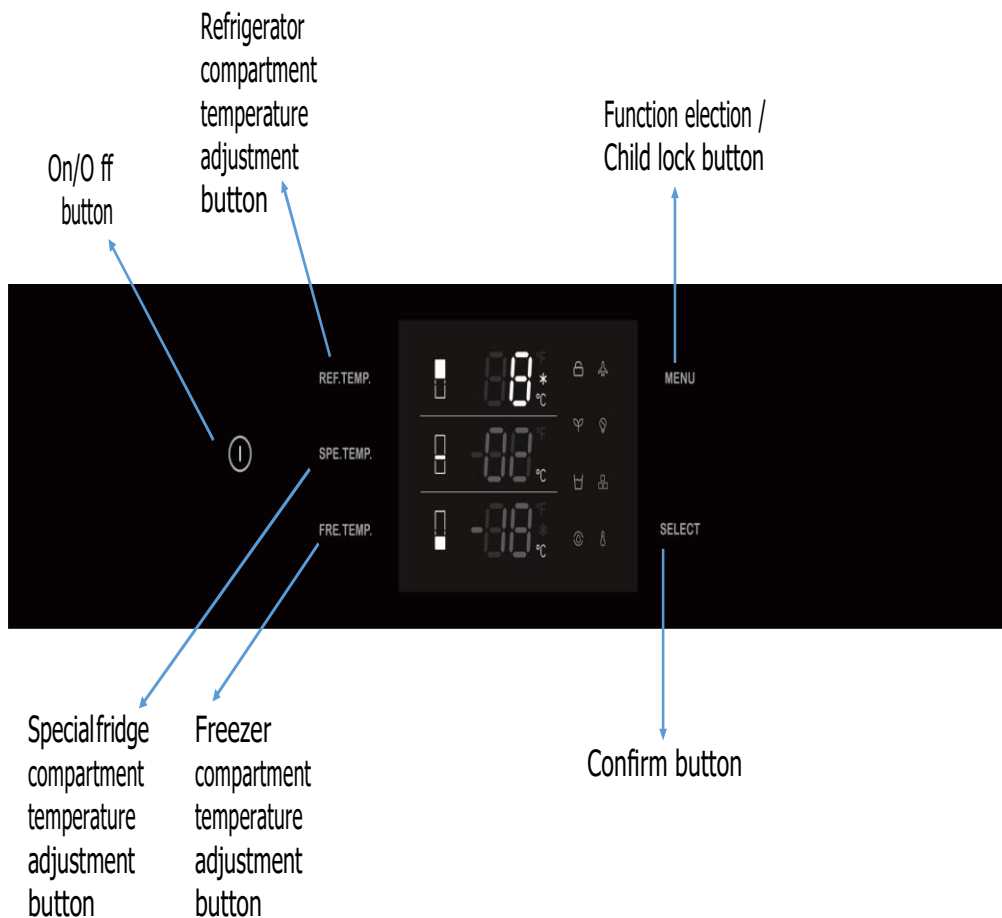

May not be available in all models

1.1 ON/OFF

Serves to switch the whole appliance On and Off . Press the button to switch on the product, the product will be switched on in 5 seconds. Press the on/off button for 1.5 seconds to switch off .

1.2 Lock and unlock

The child lock is a feature for preventing children from changing the product settings. By Pressing MENU button for 3 seconds, you may lock/unlock the control panel. The lock symbol will illuminate on the display when this function is enabled

1.3 Refrigerator compartment setting function

Press the REF TEMP button to adjust the temperature from 36 °F (2°C) to 46°F (8°C) The best temperature for fresh food compartment is 37 °F (3°C).

1.4 Special fridge compartment setting function

Press the SPE TEMP button to change the special fridge compartment temperature from 30°F (-1°C) to 41°F (5°C)

1.5 Freezer compartment setting function

Press the FRE TEMP button to change the freezer compartment temperature from 5°F (-15°C) to -11°F (-24°C)

*Super freezing function will be enabled if keep pressing after - 11°F (-24°C) . When the snow symbol illuminate on the display the super freezer function will be enabled.

NOTE: The defaulted temperature setting is 41°F (5°C) for fridge compartment, 36°F (2°C) for special fridge compartment and 0°F (-18°C) for freezer compartment

1.6 Holiday Mode

Press the MENU button till the holiday symbol illuminates, then press the SELECT button to enable the function. When the Holiday Mode function is enabled, the fridge temperature will be set at 63°F (17°C) and freezer temperature set at 0°F (-18°C) automatically.

NOTE: Do not place food in the fresh food compartment when Holiday Mode is enabled.

1.7 Sabbath Mode

Press the MENU button till the Sabbath mode symbol illuminates, then press the SELECT button to enable the function. When the Sabbath mode function is enabled, all lights, buzzers, display panels will be switch off.

1.8 Eco Mode

Press the MENU button till the Eco Mode illuminates, then press the SELECT button to enable the function. When the Eco Mode function is enabled, the fridge temperature will be set at 46 ° F (8 ° C) and freezer temperature set at 5 ° F (-15 ° C) automatically

1.9 Water Dispenser (if applicable)

Press the MENU button till the water dispenser symbol illuminates, then press the SELECT button to enable the function. When the water dispensing function is enabled, fresh water can be provided from the dispenser fitted on the internal wall.

2.10 Ice Making (if applicable)

Press the MENU button till the ice making symbol illuminates, then press the SELECT button to enable the function. When the ice making function is enabled, ice maker will be automatically operating, and the ice cubes will be accumulated in the ice tray.

NOTE: Prepare the water filter for use before using the ice. After connecting the refrigerator to a water source or after replacing the water filter, fill and discard two full containers of ice.

2.11 Water filter replacement (if applicable)

The water filter symbol flashes and beeps to advise the user to replace the water filter. After the replacement is completed, press the SELECT button for 5 seconds to reset. The set replacement time is 130 days.

2.12 Celsius and Fahrenheit selection

Press the MENU button till the Celsius and Fahrenheit selection symbol illuminates to change between Celsius and Fahrenheit. After that press the SELECT button to confirm.

Error Codes

Error Codes	Error Explanation
<u>F1</u>	Fresh Food Compartment Air Sensor Error
<u>F2</u>	Defrost Fridge Sensor Error
<u>F3</u>	Special fridge Compartment Air Sensor Error
<u>F4</u>	Freezer Compartment Air Sensor Error
<u>F5</u>	Defrost Freezer Sensor Error
<u>F6</u>	Ambient Compartment Air Sensor Error
<u>CE</u>	Communication Failure
<u>1E</u>	Fridge Fan Error
<u>2E</u>	Freezer Fan Error
<u>3E</u>	Condenser Fan Error
<u>DR</u>	The Refrigerator Opens For More Than 2 Minutes
<u>Warning Icon</u>	High Temperature Error

Knowing the connection numbers on the control board will be necessary for the following error code explanations.

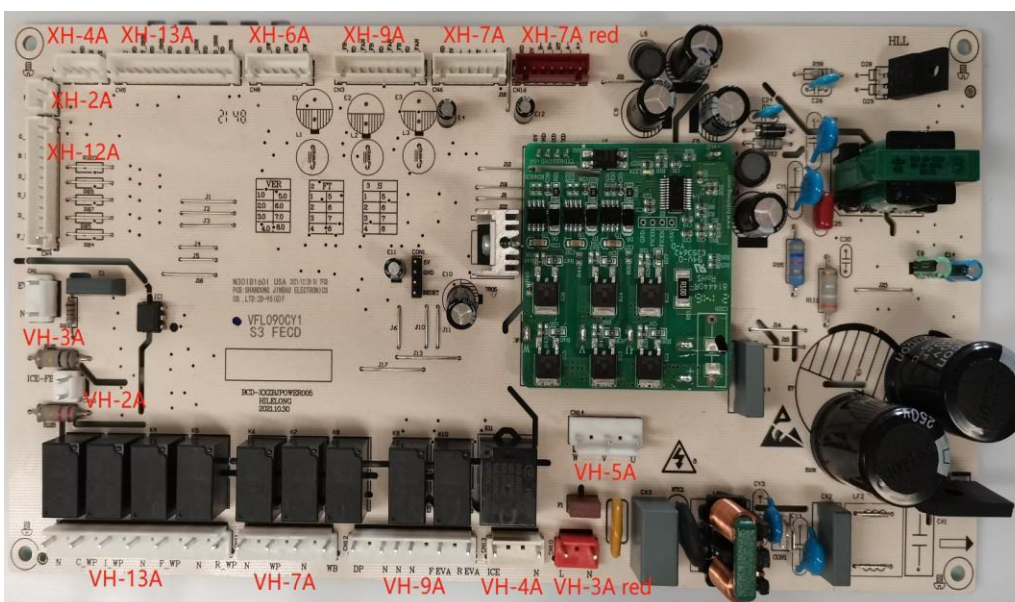

Control Board Connection Numbers	
XH-13A	Sensors
XH-9A	Fans
XH-6A	Door & Water Switch
XH-12A	Lights
XH-4A	User Interface
XH-7A	Special Fridge Damper Motor
XH-7A red	Fridge Damper Motor
VH-13A	Water Valve
VH-3A	Solenoid Valve
VH-2A VH-4A	Ice Maker
XH-2A	Empty
VH-7A	Water Pipe Heater
VH-9A	Defrosting and drainage Heater
VH-5A	Compressor input power supply
VH-3A red	Power plug input

F1 - Fresh Food Compartment Air Sensor Error

		Yes	No
1	Is F1 flashing?	>>2	Stop
2	Check cables connected to control board sensor socket (XH-13A) pins 1 & 2. Is the cable disconnected?	>>3	>>
3	Reconnect the cable and turn the refrigerator back on. Is error still there?	>>4	Solved
4	Remove the harness from the XH-13A socket on the control board. Using a multimeter, measure the sensor pins (1 & 2). Is the resistance reading between 1kΩ and 4kΩ. (2k at 77°F (25°C)) (See chart on page 23)	>>5	>>6
5	Replace the Control Board . (Turn refrigerator back on)	Solved	
6	Replace the faulty Sensor . (Turn refrigerator back on)		

F2 - Defrost Fridge Sensor Error

		Yes	No
1	Is F2 flashing?	>>2	Stop
2	Check cables connected to control board sensor socket (XH-13A) pins 3 & 4. Is the cable disconnected?	>>3	>>4
3	Reconnect the cable and turn the refrigerator back on. Is error still there?	>>4	Solved
4	Remove the harness from the XH-13A socket on the control board. Using a multimeter, measure the sensor pins (3 & 4). Is the resistance reading between 1kΩ and 4kΩ. (2k at 77°F (25°C)) (See chart on page 23)	>>5	>>6
5	Replace the Control Board . (Turn refrigerator back on)	Solved	
6	Replace the faulty Sensor . (Turn refrigerator back on)	Solved	

F1 Test points

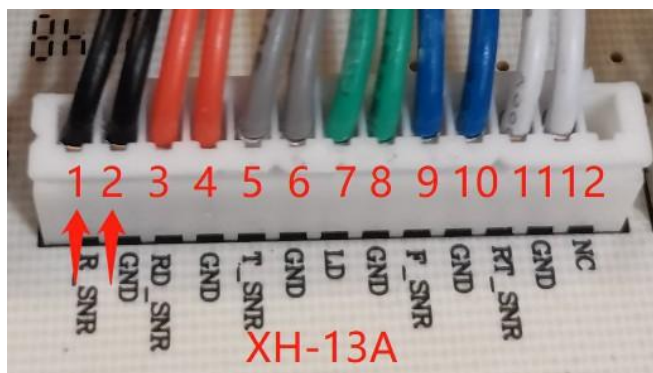

F2 Test points



F3 - Special fridge Compartment Air Sensor Error

		Yes	No
1	Is F3 flashing?	>>2	Stop
2	Check cables connected to control board sensor socket (XH-13A) pins 5 & 6. Is the cable disconnected?	>>3	>>
3	Reconnect the cable and turn the refrigerator back on. Is error still there?	>>4	Solved
4	Remove the harness from the XH-13A socket on the control board. Using a multimeter, measure the sensor pins (5 & 6). Is the resistance reading between 1kΩ and 4kΩ. (2k at 77°F (25°C)) (See chart on page 23)	>>5	>>6
5	Replace the Control Board . (Turn refrigerator back on)	Solved	
6	Replace the faulty Sensor . (Turn refrigerator back on)		

F4 - Freezer Compartment Air Sensor Error

		Yes	No
1	Is F4 flashing?	>>2	Stop
2	Check cables connected to control board sensor socket (XH-13A) pins 7 & 8. Is the cable disconnected?	>>3	>>4
3	Reconnect the cable and turn the refrigerator back on. Is error still there?	>>4	Solved
4	Remove the harness from the XH-13A socket on the control board. Using a multimeter, measure the sensor pins (7 & 8). Is the resistance reading between 1kΩ and 4kΩ. (2k at 77°F (25°C)) (See chart on page 23)	>>5	>>6
5	Replace the Control Board . (Turn refrigerator back on)	Solved	
6	Replace the faulty Sensor . (Turn refrigerator back on)	Solved	

F3 Test points



F4 Test points



F5 - Defrost Freezer Sensor Error

		Yes	No
1	Is F5 flashing?	>>2	Stop
2	Check cables connected to control board sensor socket (XH-13A) pins 9 & 10. Is the cable disconnected?	>>3	>>
3	Reconnect the cable and turn the refrigerator back on. Is error still there?	>>4	Solved
4	Remove the harness from the XH-13A socket on the control board. Using a multimeter, measure the sensor pins (9 & 10). Is the resistance reading between 1kΩ and 4kΩ. (2k at 77°F (25°C)) (See chart on page 23)	>>5	>>6
5	Replace the Control Board . (Turn refrigerator back on)	Solved	
6	Replace the faulty Sensor . (Turn refrigerator back on)	Solved	

F6 - Ambient Compartment Air Sensor Error

		Yes	No
1	Is F6 flashing?	>>2	Stop
2	Check cables connected to control board sensor socket (XH-13A) pins 11 & 12. Is the cable disconnected?	>>3	>>4
3	Reconnect the cable and turn the refrigerator back on. Is error still there?	>>4	Solved
4	Remove the harness from the XH-13A socket on the control board. Using a multimeter, measure the sensor pins (11 & 12). Is the resistance reading between 1kΩ and 4kΩ. (2k at 77°F (25°C)) (See chart on page 23)	>>5	>>6
5	Replace the Control Board . (Turn refrigerator back on)	Solved	
6	Replace the faulty Sensor . (Turn refrigerator back on)	Solved	

F5 Test points



F6 Test points



CE - Communication Failure

		Yes	No
1	Is CE flashing?	>>2	Stop
2	Check cables connected to control board socket (XH-4A) Is the cable disconnected?	>>3	>>
3	Reconnect the cable and turn the refrigerator back on. Is error still there?	>>4	Solved
4	Check cables connected to User Interface socket Is the cable disconnected?	>>5	>>6
5	Replace the Control Board . (Turn refrigerator back on)	Solved	
6	Replace the User Interface . (Turn refrigerator back on)	Solved	

CE Test points (Control Board)



CE Test points User Interface



1E- Fridge Fan Error

		Yes	No
1	Is 1E flashing?	>>2	Stop
2	Check cables connected to control board Fan socket (XH-9A) pins 1 2 & 3. Is the cable disconnected?	>>3	>>4
3	Reconnect the cable and turn the refrigerator back on. Is error still there?	>>4	Solved
4	Using a multimeter, measure the DC voltage between pins 1 & 2 Is the resistance reading approximately 12VDC?	>>5	>>6
5	Remove the evaporator cover and ensure nothing is preventing fan blade rotation. Remove blockage. Turn refrigerator back on. Is error still there?	>>6	Solved
6	Replace the Fridge Fan . Turn refrigerator back on. Is error still there?	>>7	Solved
7	Replace control board . Turn refrigerator back on.	Solved	

1E Test points



2E- Freezer Fan Error

		Yes	No
1	Is 1E flashing?	>>2	Stop
2	Check cables connected to control board Fan socket (XH-9A) pins 4 5 & 6. Is the cable disconnected?	>>3	>>4
3	Reconnect the cable and turn the refrigerator back on. Is error still there?	>>4	Solved
4	Using a multimeter, measure the DC voltage between pins 4 & 5 Is theresistance reading approximately 12VDC?	>>5	>>6
5	Remove the evaporator cover and ensure nothing is preventing fan blade rotation. Remove blockage. Turn refrigerator back on. Is error still there?	>>6	Solved
6	Replace the Freezer Fan . Turn refrigerator back on. Is error still there?	>>7	Solved
7	Replace control board . Turn refrigerator back on.	Solved	

3E - Condenser Fan Error

		Yes	No
1	Is 3E flashing?	>>2	Stop
2	Check cables connected to control board Fan socket (XH-9A) pins 7 8 & 9. Is the cable disconnected?	>>3	>>4
3	Reconnect the cable and turn the refrigerator back on. Is error still there?	>>4	Solved
4	Using a multimeter, measure the DC voltage between pins 7 & 8. Is theresistance reading approximately 12VDC?	>>5	>>6
5	Remove the compressor compartment cover and ensure nothing is preventing the condenser fan blade rotation. Remove blockage. Turn refrigerator back on. Is error still there?	>>6	Solved
6	Replace the Condenser Fan . Turn refrigerator back on. Is error still there?	>>7	Solved
7	Replace control board . Turn refrigerator back on.	Solved	

2E Test points

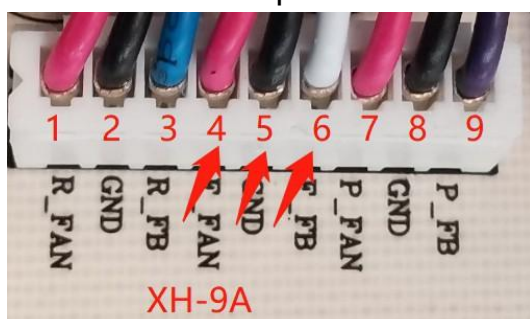

3E Test points



DR - Door opening alarm Error

		Yes	No
1	Is DR flashing?	>>2	Stop
2	Check whether the refrigeration door is closed tightly, Repeat closing the door, if the fault still exists	>>3	>>4
3	Check whether the induction magnet on the top of the door of the refrigerator is missing. If it is missing, the fault will continue	>>4	Solved
4	Check whether the magnetic switches of the upper beam are normal	>>5	Solved

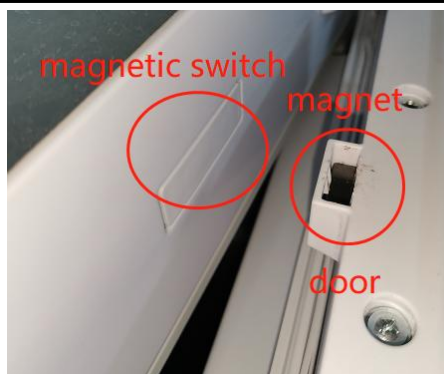

Maintenance guide for refrigeration failure

1. Freezer is not cold enough.
 - Error code on display. First, open and close the freezer door to see if the freezer light is always on. If so, check the freezer drawer brackets.
 - No error code on display. Check if the plugs on the main control board are connected properly.
 - Evacuate the gas and re-gas the system.
2. Freezer does not work
 - If the compressor works, check if the capillary is blocked.
3. Fridge does not work
 - If there is an error code F1, check the fan in the fridge. If it is still not working after replacing the fan, check the wiring connection.
 - Check if the reed switch is working properly.
 - Check if the appliance is on a holiday mode.
4. Fresh zone is not working properly
 - Check if the fresh zone is switched off.
 - Check if there is cold air blowing from the outlet, if not, replace the air duct.
5. Fridge and freezer are not working
 - Check whether the power cord plug of the main control board is off or not connected.
 - Method 2 Check whether the plugs on the main control board are fully connected or correctly connected.

Guide to maintenance of ice making faults

1. Ice maker fails

- Check whether the water inlet pipe or valve is blocked
- Check the switch of the ice maker and also the terminals of the ice maker have loose connections
- Insufficient amount of secondary ice is not formed

2. Ice amount is less and not fully shaped

- Check the water pressure
- Check whether the ice maker is installed properly
- Check whether each pipeline has extrusion deformation and bending

3. Water leakage

- Check the water valve leakage. whether the pipeline is in place, and the clip is installed.
- Check whether the water filter is tightened and whether it is leaking.
- Check the water storage pipes and joints

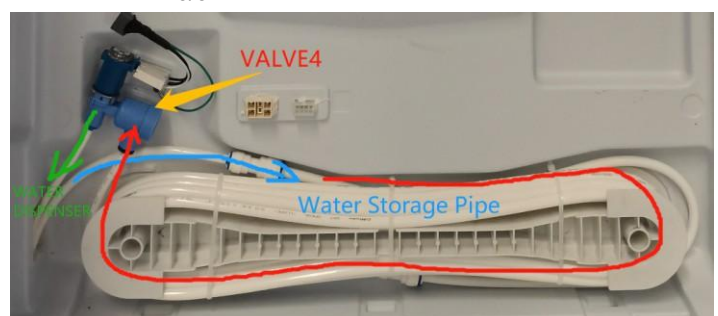
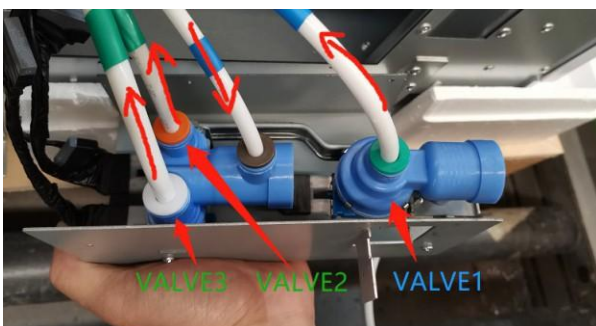
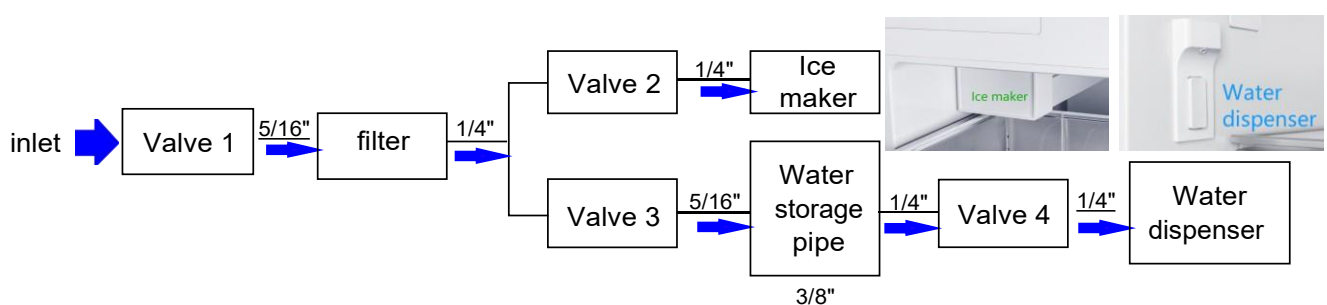

High Temp Error

When the temperature collected by the freezing sensor reaches set 39°F(+4°C), if the temperature rises $\geq 30^\circ\text{F}(-1^\circ\text{C})$, the high temperature alarm will buzz twice consecutively, and the freezing temperature LED light will flash; Touch any button, the over-temperature alarm sound will be canceled, but the freezing temperature LED light will continue to flash; The alarm will stop only when the temperature collected by the sensor is less than 28°F(-2°C).

If the over-temperature alarm continues after rebooting the appliance, it is necessary to check whether the refrigeration system is blocked, and whether the compressor and fan are working properly.

Temperature to Resistance Chart

Low Range			
Temp	Resistance	Temp	Resistance
-40°F/-40°C	64.06KΩ	-15°F/-26°C	27.07KΩ
-38°F/-39°C	60.10KΩ	-13°F/-25°C	25.52KΩ
-36°F/-38°C	56.41KΩ	-11°F/-24°C	24.06KΩ
-35°F/-37°C	52.96KΩ	-9°F/-23°C	22.70KΩ
-33°F/-36°C	49.74KΩ	-8°F/-22°C	21.42KΩ
-31°F/-35°C	46.73KΩ	-6°F/-21°C	20.22KΩ
-29°F/-34°C	43.92KΩ	-4°F/-20°C	19.10KΩ
-27°F/-33°C	41.29KΩ	-2°F/-19°C	18.04KΩ
-26°F/-32°C	38.83KΩ	-.3°F/-18°C	17.05KΩ
-24°F/-31°C	36.53KΩ	1°F/-17°C	16.11KΩ
-22°F/-30°C	34.38KΩ	3°F/-16°C	15.24KΩ
-20°F/-29°C	32.37KΩ	5°F/-15°C	14.41KΩ
-18°F/-28°C	30.49KΩ	7°F/-14°C	13.64KΩ
-17°F/-27°C	28.72KΩ	9°F/-13°C	12.91KΩ

Normal Operator Range			
Temp	Resistance	Temp	Resistance
10°F/-12°C	12.22KΩ	59°F/15°C	3.13KΩ
12°F/-11°C	11.57KΩ	61°F/16°C	2.99KΩ
14°F/-10°C	10.96KΩ	63°F/17°C	2.85KΩ
16°F/-09°C	10.39KΩ	64°F/18°C	2.73KΩ
18°F/-08°C	9.85KΩ	66°F/19°C	2.60KΩ
19°F/-07°C	9.34KΩ	68°F/20°C	2.49KΩ
21°F/-06°C	8.86KΩ	70°F/21°C	2.38KΩ
23°F/-05°C	8.41KΩ	72°F/22°C	2.28KΩ
25°F/-04°C	7.98KΩ	73°F/23°C	2.18KΩ
27°F/-03°C	7.57KΩ	75°F/24°C	2.08KΩ
28°F/-02°C	7.19KΩ	77°F/25°C	1.99KΩ
30°F/-01°C	6.83KΩ	79°F/26°C	1.91KΩ
32°F/00°C	6.49KΩ	81°F/27°C	1.83KΩ
34°F/01°C	6.17KΩ	82°F/28°C	1.75KΩ
36°F/02°C	5.87KΩ	84°F/29°C	1.68KΩ
37°F/03°C	5.58KΩ	86°F/30°C	1.61KΩ
39°F/04°C	5.31KΩ	88°F/31°C	1.54KΩ
41°F/05°C	5.06KΩ	90°F/32°C	1.48KΩ
43°F/06°C	4.81KΩ	91°F/33°C	1.41KΩ
45°F/07°C	4.58KΩ	93°F/34°C	1.36KΩ
46°F/08°C	4.37KΩ	95°F/35°C	1.30KΩ
48°F/09°C	4.16KΩ	97°F/36°C	1.25KΩ
50°F/10°C	3.96KΩ	99°F/37°C	1.20KΩ
52°F/11°C	3.78KΩ	100°F/38°C	1.15KΩ
54°F/12°C	3.60KΩ	102°F/39°C	1.11KΩ
55°F/13°C	3.44KΩ	104°F/40°C	1.06KΩ
57°F/14°C	3.28KΩ		

Wiring Diagram

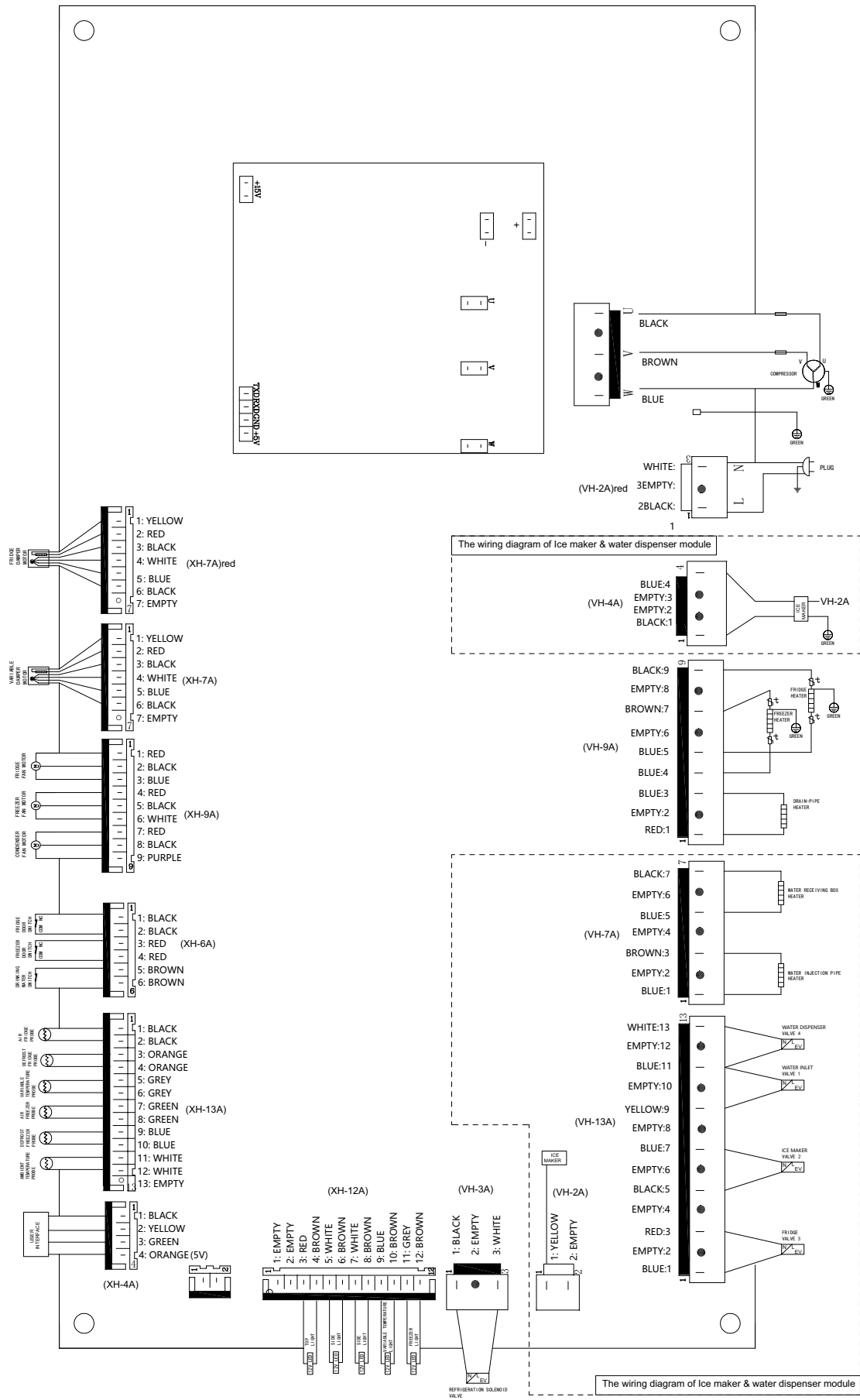

Control Board Test Points (See the picture on page 15 for the control board)

XH-13A	Temp Sensors	Contacts	Values
	Air FridgeProbe	1&2	(See chart on page 23)
	Defrost FridgeProbe	3&4	
	Variable Temperature Probe	5&6	
	Air Freezer Probe	7&8	
	Defrost FreezerProbe	9&10	
	Ambient Temperature Probe	11&12	
XH-6A	Reed Switch	Contacts	Values
	Fridge Door Switch	1&2	Continuity when Open
	Freezer Door Switch	3&4	Continuity when closed
	Drinking Water Switch	5&6	Continuity when closed
XH-9A	Fans	Contacts	Values
	Fridge Fan Motor	1-3	12VDC
	Freezer Fan Motor	4-6	12VDC
	Condenser Fan Motor	7-9	12VDC
XH-12A	Lights	Contacts	Values
	Top Light	3&4	12VDC
	Side Light	5&6	12VDC
	Side Light	7&8	12VDC
	Variable Temperature Light	9&10	12VDC
	Freezer Light	11&12	12VDC
XH-4A	Display Voltage	3&4	5VDC
XH-7A	Variable Damper Motor	1-6	12VDC
XH-7A red	Fridge Damper Motor	1-6	12VDC
VH-7A	Water Heater	Contacts	Values
	Water Injection Pipe Heater	1&3	120VAC
	Water Receiving Box Heater	5&7	120VAC
VH-9A	Ac Components	Contacts	Values
	Drain-Pipe Heater	1&3	120VAC
	Freezer Heater	4&7	120VAC
	Fridge Heater	5&9	120VAC
VH-13A	Water Valve	Contacts	Values
	Fridge Valve	1&3	120VAC
	Ice Maker Valve	5&7	120VAC
	Water Inlet Valve	9&11	120VAC
	Water Dispenser Valve	11&13	120VAC
VH-3A	Refrigeration Solenoid Valve	1&3	120VAC
VH-4A	Ice Maker	1&4	120VAC
VH-2A	Ice Maker	1	120VAC
VH-3A red	Plug	1&3	120VAC
VH-5A	Compressor	W&V&U	120VAC

Main control board led flashing fault

Compressor does not start - list of fault codes prompted by main control panel indicator				
Serial number	Flashing times of main control panel LED	Main control board fault	Cause analysis of compressor failure	terms of settlement
1	LED flashes once	Overvoltage	1. The input voltage is too high, and the input voltage of 110V model is higher than 110V (this situation will cause the control board to burn out, the machine will not work, and there is no response) 2. Abnormal control board	1. Check whether the power supply voltage is normal 2. Disconnect the power and restart the machine 3. Replace the control board
2	LED flashes twice	Undervoltage	1. The input voltage is low, and the input voltage of 220V model is lower than 110V 2. Abnormal control board	1. Check whether the power supply voltage is normal 2. Disconnect the power and restart the machine 3. Replace the control board
3	LED flashes 3 times	communication	1. Abnormal data transmission between main board and frequency conversion board	1. Disconnect the power and restart the machine 2. Replace the control board
4	LED flashes 4 times	Phase deficiency	1. The compressor harness is not connected properly 2. The fuse on the compressor line is burnt out 3. The compressor is broken	1. Check the compressor line sequence 2. Check whether the fuse is burnt 3. Replace the compressor if there is no problem above
5	LED flashes 7 times	Software overcurrent	1. The actual current reaches the current threshold set by the software (the protection threshold setting is too small) 2. The software has a bug and does not meet the protection status required by special requirements	1. Disconnect the power and restart the machine 2. Replace the control board
6	LED flashes 10 times	Start failure, small board current detection circuit failure	1. The control board is broken 2. The solenoid valve is broken, resulting in excessive system pressure 3. The compressor is broken and the cylinder is jammed	1. Disconnect the power and restart the machine 2. Replace the control board 3. Replace the solenoid valve 4. Replace the compressor
7	LED flashes 12 times	Hardware overcurrent	1. The current detection is too large due to hardware components 2. Special abnormality causes damage to the components of the frequency conversion board, resulting in abnormality of the frequency conversion board	1. Replace the control board
8	LED flashes 14 times	Stall	1. Compressor internal jamming 2. The compressor is unstable 3. Wrong line sequence	1. Check whether the wire sequence UVW is connected properly 2. Check whether the compressor is aligned 3. Replace the compressor

Note: If the number 5, 6, 7 and 8 are abnormal, the theoretical priority is 6; No. 6 Normally, No. 8 appears first, followed by No. 5, and finally No. 7

The above phenomena are detected by current, Therefore, there are many factors that cause the current change:

- 1.The system pressure is abnormal
- 2.The solenoid valve is not conductive
- 3.The control board hardware is abnormal.
- 4.Ice jam.
- 5.The threshold set by the software is not large enough

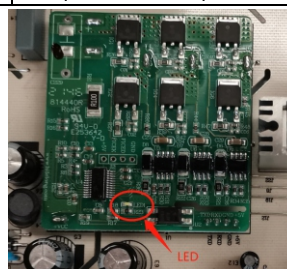

Component Access and Removal



Disassembly should only be done with the product unplugged and by an authorized technician.

Control Board



1、 Remove the ventilation window 4 screws

2、 Pull out the ventilation window

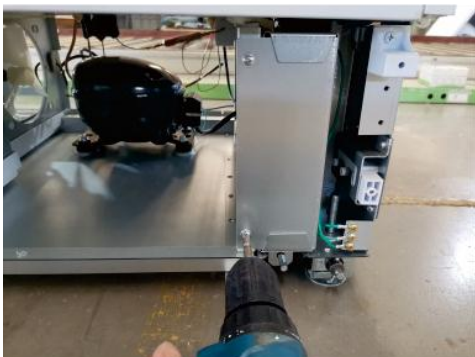

3. Remove the 2 screws that fix the main control board

4. Pull out the main control board box

5. remove the four main control board box cover screws



6. The main control board disassembly is completed

Display



1. Remove the 2 screws at the bottom of the display partition
2. Pull out the display partition

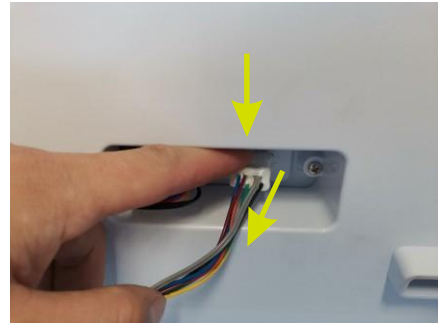

3. press the display board connection cable terminal self-locking snap, disconnect



4. Remove the 5 screws on the back of the display partition
5. Use a word screwdriver to pry open the upper and lower cover clips

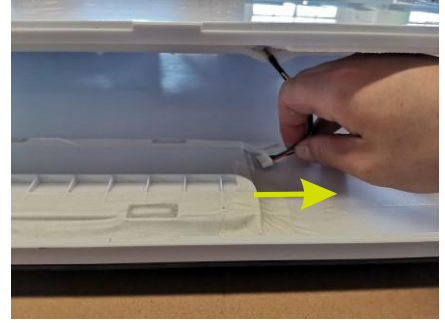

6. Unplug the display board connection cable



7. Open the top and bottom cover of the display panel and remove the protective cover tape of the display panel

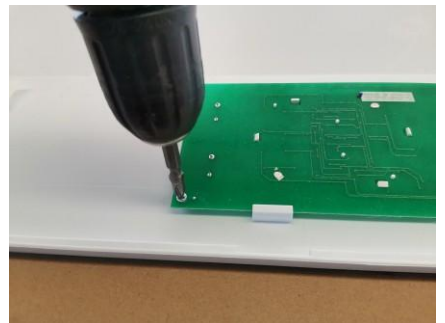

8. Remove the 2 screws securing the display board

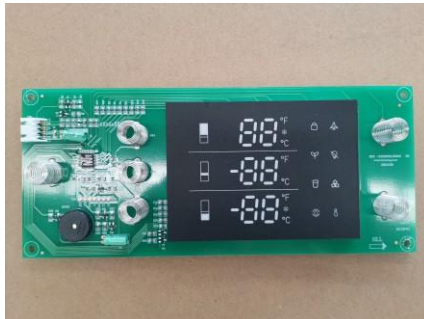
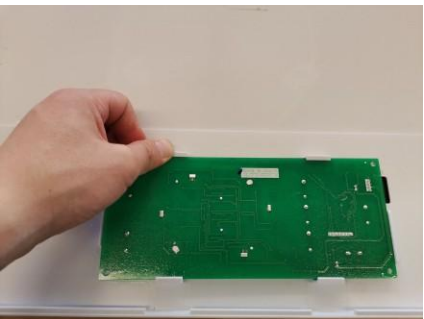

9. Remove the display board by pressing the clips that hold it in place

Temperature inside the box Sensor



1. Use the flat shovel to pry open the box temperature sensor box cover

2. Open the box lid

3. Separation of the lid from the sensor

Environmental Temperature sensor

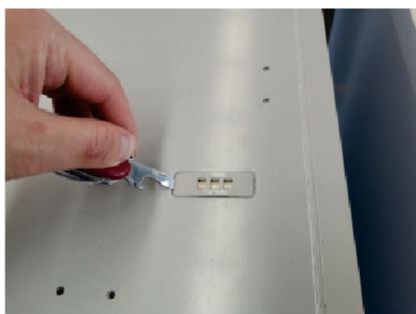

1. The case temperature sensor is located at the top of the refrigerator

2. Use a screwdriver to pry open the ring temperature sensor box cover

3. Open the ring temperature sensor



Refrigerator magnetic light switch



1. Use the flat shovel to pry open the magnetic switch box cover



2. Press the connector self-locking catch to remove the magnetic switch

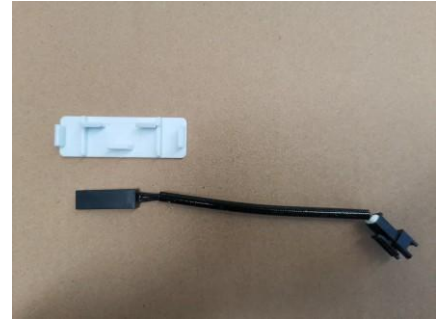

Freezer light switch



1. Use a flat shovel to pry open the light switch



2. Pull out light switch

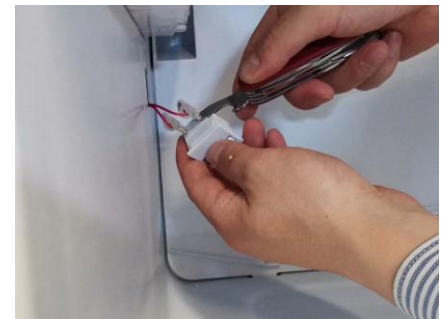

3. Use a screwdriver to pry open the T-terminals



Refrigeration room Overhead light



1. Use tools to remove the top light cover screws
2. Press the circle position to remove the top light cover



3. Press the light bar snap to remove the top light

Icehouse light



1. Icehouse light bar on the back of the display compartment
2. Use a screwdriver to remove the icehouse shade
3. Press the light bar snap to remove the light



Side light

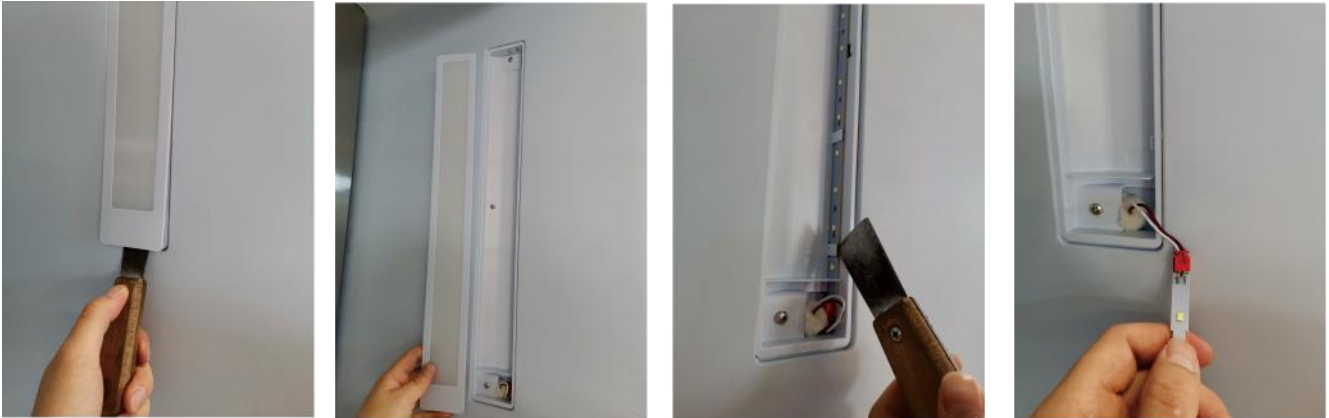

1. Pry open the sidelight cover with a flat shovel
2. Press the light bar snap to remove the sidelight



Freezer overhead light



1. Use a flat shovel to pry open the frozen dome light cover
2. Press the light bar snap to remove the light

Refrigerator upper rail removal

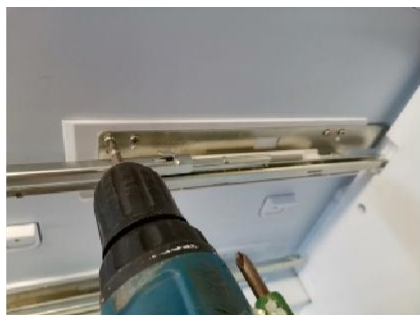

1. Removal of refrigerated upper rail set screws using tools
2. Separate the guide from the fixings

Reefer lower rail removal



1. Use tools to remove the refrigerated lower rail fixing screws
2. Separate the guide from the fixings

Vegetable box disassembly



1. Pull out the fruit and vegetable box



2. Press the snap on both sides of the fruit and vegetable box



3. Take out the fruit and vegetable box



Freezing lower drawer disassembly



1. Pull out the freezer door body and remove the 4 handscrews



2. Lift both sides of the drawer with both hands and flip it over to take out the freezer drawer



Freezer upper rail removal



1. Removal of the freezing upper rail fixing screw using a tool 2. Circles are fixed with snaps



3. Use a screwdriver to pry open the fasteners to separate the rails from the fasteners

Freezer lower rail removal



1. Removal of frozen lower rail set screws using tools 2. Circles are fixed with snaps



3. Use a screwdriver to pry open the fasteners to separate the rails from the fasteners

Freezer top drawer removal



1. Pull out the freezer top drawer



2. Lift up and take out the frozen top drawer



Door handle removal



1. Use an Allen wrench to remove the set screw on the side of the handle base

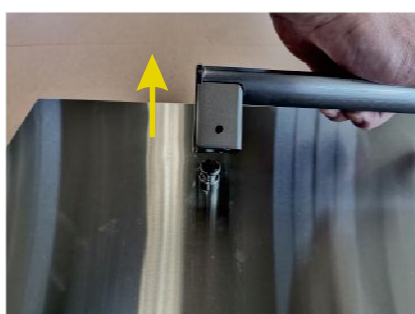

2. Remove the handle assembly after the set screw is removed

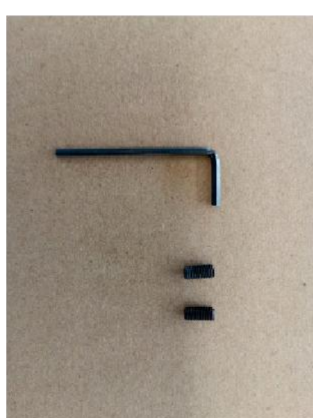
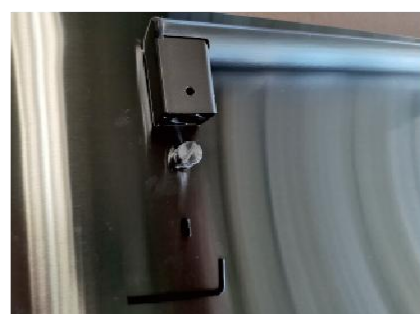

Ice Maker



1. Open the drawer door



2. Take out the drawer



3. Remove the screws holding the ice maker in place



4. Unplug the terminals and remove the ice machine

Freezer the Rear Wall



1. Take out the ice machine and remove the slides on both sides



2. Remove the air duct fixing screws



3. Remove the air duct cover

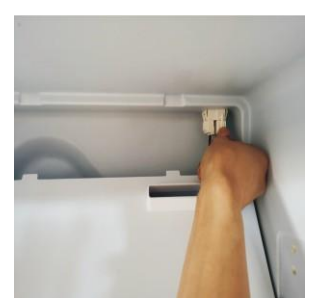

4. Unplug the terminal block and remove the cover plate



5. Remove the sensor

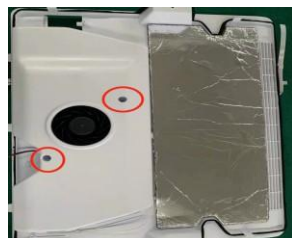

6. Remove the fan cover



7. Removing the freezing fan



8. Take out the fan

Removing the Rear Wall



1. Remove the cover plate fixing screws



2. Unplug the terminal block



3. Remove the air duct coverplate



4. Remove the fan cover fixing screws



5. Remove the fancover

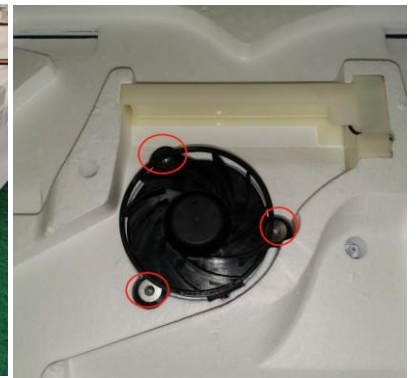

6. Removing the fan

Refrigerated water valve



1. Remove the fixing screws and water pipes



2. Unplug the terminal to remove the water valve

Water Dispenser & Microswitch



1. Use the flat shovel to pry open the right side of the cover



1. Pull out from topto bottom



3. Carefully remove the microswitch

Dispenser Water Valve

Remove the water valve from the side of the box



1. Remove the four screws securing the water valve from the side

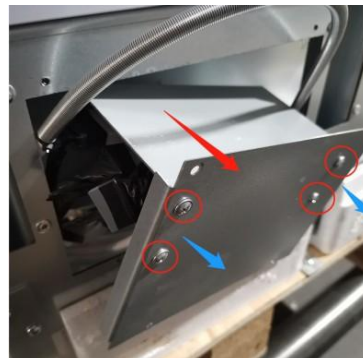

2. Pull out the box and remove the four screws



3. Pull out the water pipes on the water valve one by one

Remove the water valve from the front of the box



1. Remove the four screws securing the water valve from the front



2. Pull out the water valve fixing bracket outward



3. Pull out the water pipes on the water valve one by one

Defrost Element & Thermal Fuse+

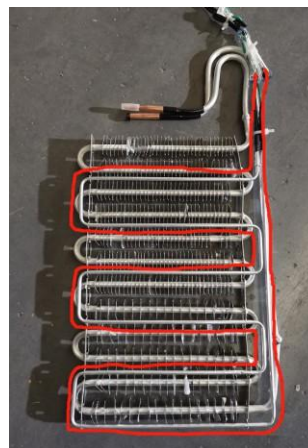
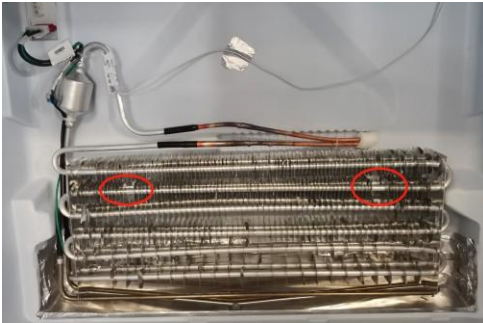

1. Pull out the freezer top drawer. Carefully pull forward on the evaporator to unclip it from the rear wall. Remove the two retaining clips from the front of the evaporator.

2. Carefully peel the defrost element off of the front of the evaporator. Peel the defrost off the back and remove. Replace in reverse order.

Condenser Fan

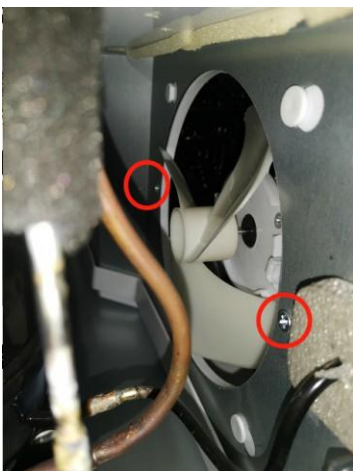

1. Remove the two set screws



2. Unplug the terminal to remove the fan

Troubleshooting

Symptom	Possible Cause	Corrective Action
The Freezer compartment is too cold, but the refrigerator temperature is fine.	The Freezer compartment temperature is set too low.	Set Freezer temperature to a higher setting.
The Fresh Food compartment is too cold , but the Freezer temperature is fine.	The Fresh Food temperature is set too low.	Set Fresh Food temperature to a higher setting.
	Door not sealing	Check door gaskets.
	Fan not running	Check fan.
The refrigerator's operating sounds varies over time.	The operating sounds will vary according to different cycles, food volume and environmental conditions.	This is normal.
The refrigerator makes vibration or other strange noises.	Various components make vibration sounds, such as when water valves energize. Also gas flowing through refrigerant lines can make gurgling noises. And popping and sizzling sounds can occur during the defrost cycle.	As long as both compartments are maintaining proper temperatures, these sounds are normal.
Evaporator Fan is noisy.	The fan blade may be irregular.	Remove evaporator cover and inspect fan for irregularities. Replace if necessary.
	Fan blade may be hitting something.	Remove evaporator cover and inspect fan area for any obstructions. Adjust fan or remove obstructions.
	Fan speed may be too high.	Check fan speed for proper RPMs. Fan may be noisy if RPMs are too high. Replace fan motor, if so.
Condenser Fan is noisy.	The fan blade may be irregular.	Remove compressor cover and inspect fan for irregularities. Replace if necessary.
	Fan blade may be hitting something.	Remove compressor cover and inspect the fan area for any obstructions. Adjust fan or remove obstructions.
	Fan speed may be too high	Check fan speed for proper RPMs. Fan may be noisy if RPMs are too high. Replace fan motor, if so.
	Dust and debris may have ruined fan motor	Replace fan motor.

Troubleshooting

Symptom	Possible Cause	Corrective Action
Condensation develops on outside of refrigerator, or between doors.	Excessive ambient heat or humidity can cause moisture to develop on cooler surfaces.	It is normal during hot or humid seasons to see increased condensation on the outside of the unit. This will decrease as ambient humidity goes away.
		Flapper heater between doors may not be operating properly. Inspect and replace, if necessary.
Refrigerator doors will not close.	Something may be blocking the door.	Check food placement and adjust if necessary.
	The door gasket may not be seating properly	Inspect gasket. Adjust or replace.
The doors squeak when opening or closing.	Door hinges are worn.	Replace door hinges.
Water cannot be dispensed from the water dispenser.	Water supply may be turned off.	Ensure water to refrigerator is turned on.
	The dispenser switch may be faulty.	Inspect dispenser switch and replace, if necessary.
	The water valve(s) may be faulty.	Inspect water valves in Service Mode. Replace, if necessary.